

CASES 2013

**HPRC**<sup>®</sup>  
HIGH PERFORMANCE RESIN CASES





#### OUR BRAND

WE'RE ABOUT HAPPINESS BY CASES. IT MEANS WE'RE NOT JUST IN THE BUSINESS OF CREATING PROTECTIVE CASE, EVEN THOUGH THAT IS WHAT WE DO. EVERYTHING WE DO IS DESIGNED TO MAKE PEOPLE HAPPY.  
FROM AN EVER - GROWING COLLECTION OF INNOVATIVE PRODUCTS TO OUR PASSIONATE TEAM WHO MAKES IT HAPPEN, IT'S ALL ABOUT HAPPINESS.

#### OUR PRODUCTS

WE'RE ALWAYS LOOKING FOR WHAT'S NEXT. WE'RE CONSTANTLY INNOVATING. OUR ORIGINAL DESIGNS FORM AND FUNCTION, CREATING A FRESH APPROACH TO THE ART OF CASES. WE INCORPORATE STYLES, TOP MATERIALS AND EYE-CATCHING PATTERNS INTO OUR DESIGNS TO MAKE MORE THAN A CASE. WE MAKE A STATEMENT.

#### OUR HISTORY

PLABER - HPRC CASES BEGAN WITH ONE SIMPLE PREMISE: WE CAN DESIGN A BETTER CASE. THE IDEA STARTED IN 2006. PLABER HAS GROWN INTO A SUCCESSFUL INTERNATIONAL BUSINESS, PARTNERING WITH IMPORTANT COMPANIES AND PARTNERS. OUR PRODUCTS CAN BE FOUND IN 76 COUNTRIES AND HAVE GARNERED TOP AWARDS AND PRAISE. AS WE GROW, OUR ENTREPRENEURIAL SPIRIT CONTINUES TO DRIVE THE HPRC CULTURE. AFTER ALL, IT'S WHAT HELPED US BUILD THE WORLD'S EMERGING HARD CASES BRAND.

H P R C C A S E S  
**MADE IN ITALY**



## COMMITMENTS TO OUR CUSTOMERS: WE UNDERTAKE TO:

1. **UNDERSTAND** THE PROBLEMS OF YOUR MARKET AND YOUR SPECIFIC REQUIREMENT. OUR STRENGTHS: EXPERT KNOWLEDGE OF TECHNOLOGICAL AND ECONOMIC TRENDS, AN UNCOMPROMISINGLY INDIVIDUAL APPROACH TO EACH CUSTOMER.

2. **FIND** A CASE/TRANSPORT SOLUTION TAILORED TO YOUR REQUIREMENT. OUR STRENGTHS: EXTENSIVE RANGE IN THE MARKET; SOLUTIONS BEYOND OUR PRODUCT OFFER; TEAMS THAT ASSIST YOU IN SELECTING FROM THIS RANGE THE GRADE THAT IS BEST SUITED TO YOUR OWN REQUIREMENT.

3. **LISTEN** TO AND TAKE ACCOUNT OF YOUR COMMENTS, THROUGH OUR NETWORK OF EXPERTS AND REGULAR SATISFACTION SURVEYS.

4. **BE** INNOVATIVE AND COMPETITIVE IN PROFESSIONAL CASES MARKET.

plaber  
ITALIA

Ultralight. Watertight. **Smart Cases.**

# HPRC: INNOVATION, TECHNOLOGY AND DESIGN.

PROUDLY  
**MADE IN ITALY**



MOST OF HARD WATERTIGHT CASES ARE MADE IN STANDARD PP: OUR R&D DEPARTMENT HAS DEVELOPED AN ENHANCED COMPOUND, STILL BASED ON PP, NOW BALANCED WITH ADDITIONAL HIGH PERFORMANCE RESINS.

**TTX01®** ALLOW TO PRODUCE CASES LIGHTER IN WEIGHT, STRONGER IN ROBUSTNESS.

HOW? THE SPECIAL MIX WE ADDED, MAKE THE WALLS OF THE HPRC SHELL MORE ELASTIC AND THINNER, INCREASING THE SHOCKPROOF DEGREE AND THE LIGHTWEIGHT.

ON THE TOP OF THAT, MAINTAINING PP CHARACTERISTICS, HPRC ARE ACIDPROOF, SCRATCHPROOF, ABLE TO RESIST TO EXTREME WEATHER CONDITIONS AND TEMPERATURE CHANGES (ALL THE SIZES ARE TESTED FROM - 40° C UP TO 80°C).

DO YOU WANT TO KNOW MORE?

PLEASE CONTACT OUR TECHNICAL TEAM: [TECH@HPRC.IT](mailto:TECH@HPRC.IT)



AIREX IS THE NEW AUTOMATIC PURGE VALVE THAT IS AUTO PRESS RELEASE ADJUSTED TO CHANGING ENVIRONMENTS AUTOMATICALLY.



LIFE TIME WARRANTY HPRC: THE PLABER'S PRODUCTS, HAVE BEEN BUILT TO RIGOROUS STANDARDS OF QUALITY AND ARE GUARANTEED AGAINST ALL DEFECTS IN MATERIALS AND WORKMANSHIP FOR THE LIFE OF THE CASE.



POLE: ALU

BODY: TTX01® HARDWARE: STEEL

WHEELS: PA66+PUR

HANDLE: PP+SEBS

LATCHES: POM

EXT.HANDLE: PA66GF30

## THE ATTENTION AND THE RESPECT TOWARD THE ENVIRONMENT THAT SURROUND US AND AN ECO-SUSTAINABLE FUTURE ARE IMPORTANT VALUES FOR PLABER;



OUR COMMITMENT STARTS FROM THE DESIGNING PHASE OF THE PRODUCT TO THE MANAGEMENT OF THE IMPACT OF THE PRODUCT'S END LIFE. SHELLS AND **ALL THE COMPONENTS OF THE HPRC CASES ARE 100% RECYCLABLE** AS THE DISCARDS OF PRODUCTION AND TRANSFORMATION ARE DIVIDED FOR TYPOLOGY AND SUBSEQUENTLY REINTEGRATED IN THE PRODUCTIVE CYCLE.

THE RESISTANCE OF THE PATENTED MATERIAL TTX01® ALLOWS TO RE-USE OF THE HPRC CASE LONGER THAN ANY OTHER TYPE OF TRANSPORT CASE, REDUCING THEREFORE THE EMISSIONS OF CO2 CREATED FOR THE PRODUCTION AND DISPOSAL OF THE PRODUCT. THE CONSTANT QUEST OF SUPPLIERS WITH ISO 14000 OR EMAS CERTIFICATION AND GEOGRAPHICALLY CLOSE TO PLABER, IS A CONTRIBUTOR TO THE **REDUCTION OF THE IMPACT ON THE ENVIRONMENT** AND IT REPRESENTS A CHALLENGE IN A WORLD WHERE FIRMS ARE LOOKING ONLY FOR LOWER PRICE SUPPLIERS BUT, ON THE OTHER HANDS, WITH AN HIGHER ENVIRONMENTAL IMPACT.

**FURTHER STRATEGIC ELEMENT** IS THE ADOPTION OF RENEWABLE SOURCES PLANTS FOR ENERGY PRODUCTION, NECESSARY FOR THE COVERAGE OF THE ENERGETIC NEEDS.

**HPRC** we case in **green.**

# STANDARD

1



*\* EMPTY  
USA: E*

2



*\* CUBED FOAM  
USA: F*

3



*\* CORDURA BAG  
USA: IC*

4



*\* SOFT PADDED OPEN  
DECK + DIVIDERS  
USA: DK*

*\* PANEL FRAME  
MOUNTING SYSTEM  
AVAILABLE*



**WE ARE CASE PRODUCERS.  
IF YOU DO NOT FIND THE SIZE OR LIKED DESIGN  
WE CAN MAKE A NEW CASE FOR YOU**

**INQUIRE ABOUT PRODUCT >>>> MOLD + PRODUCT PRICE OFFER**

**SIGN CONTRACT >>>> DESIGN DROWING**

**CLIENT CONFIRMS >>>> MOLD MAKING**

**CHECK SAMPLE >>>> ARRANGE 4 PRODUCTION**

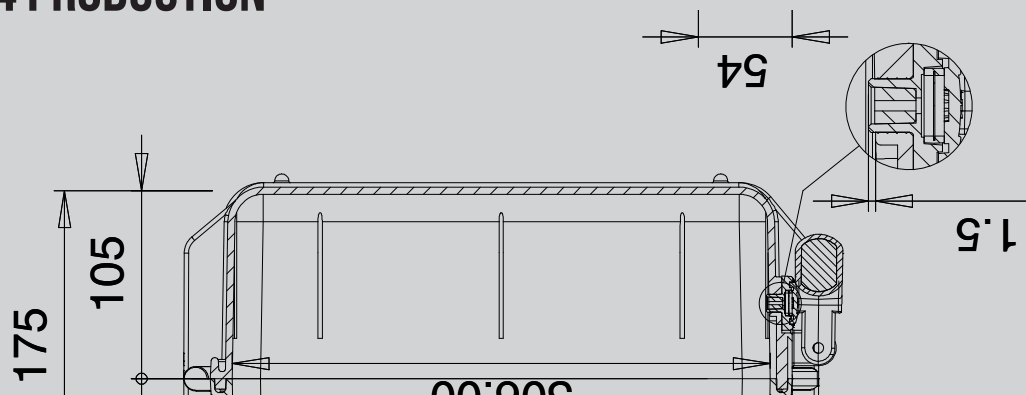

# Custom fit

CUSTOMIZATION CONCERN COLOURS, PRINTING, ADHESIVE, FOAM INLAY (DIE CUT, WATER CUT, MILLED, MOULDED), THERMOFORMED INLAY, LID PANELS AND ORGANIZER, WORKING TO THE CASES SHELL (HOLES, EXTERNAL APPLICATIONS) KEEPING THE WATER TIGHTNESS WHEN REQUESTED.



This special high-visibility inlay is designed in order to avoid forgetting equipment on the field after the use.



We give customers different equipment layouts options in order to optimize space and the handiness.



Customization also includes the possibility to design solutions for the use of the cover as glove compartment. Our solutions include organizers, special tools addition and shell modifications, special colors.



Plaber's OEM service can provide shell customization, including holes for external connections. HPRC panel frame accessory (HPRCPF) allows customers to install a control panel into the case, ensuring a perfect fit.



*foam factory*®  
H P R C C A S E S

CUSTOM LABELS AND TAGS

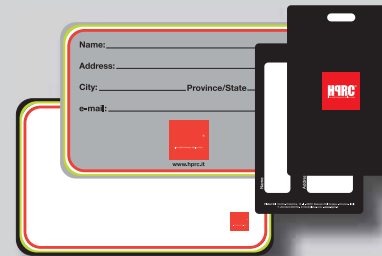

- CASE APPLICATIONS
  - CUSTOM LOGO SERVICE
  - R&D SOLUTIONS ON DEMAND
  - DEDICATED STAFF FOR DESIGNING AND BUILD CUSTOM
  - DIFFERENT WEIGHT AND CELL FOAM STRUCTURES
- OEM STAFF: OEM@HPRC.IT**



Injection inlays production: the custom inlays in expanded polypropylene of various densities guarantees a perfect protection and a professional aspect. Our service starts from the study of the mould, trough prototype and final production.



Water cutting technology foams: expanded polietilene foams, available in various densities (Kg/m<sup>3</sup>), resistance to the compression (kPa) and temperatures ranges of resistance (°C), produced with water cutting technology guarantee a good protection and allow a wide range of customizations.



Milled foams: this technology allows to get inlays made of one piece only, with many different depths.



Multi layer, handiness solution, perfect when equipment is made of high numbers of parts that must be stored and protected into one case only.

# HPRC1100



\* MEMORY CARD CASE



\* EMPTY CASE



## FEATURES

- Removable multiformat memory card holder
- Accepted card Formats: SD, Memory stick, Memory stick pro duo, Mini SD
- Holds up to 2 memory cards per format
- Full/empty indicator

\* OPEN CASES IMAGES REFLECT THE DIFFERENT HPRC CASES INTERNAL OPTIONS

<b>Dimension:</b>	<b>internal dimension</b> 58x57x25(mm) - 2,28x2,26x1 (in)
	<b>external dimension</b> 80x69x32(mm) - 3,16x2,71x1,25(in)
	<b>lid:</b> 12,80(mm) - 0,50(in) <b>bottom:</b> 12,20(mm) - 1,24(in)
<b>Weight:</b>	<b>empty:</b> 0,040kg / 0,088lbs available empty or with memory card storage
<b>Temperature rating:</b>	Minimum                      Maximum -40°C -40°F                      +80°C +176°F
<b>Colors:</b>	Black - Ferrari red



## TECHNICAL DRAWING

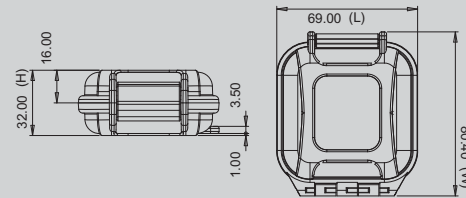

## APPROVALS

ATA 300  
IP67  
STANAG 4280  
DS 81-41

## TEST

DROP  
IMPACT  
HANDLE  
WATERTIGHT INTEGRITY  
UV COLOR AND MATERIAL PROTECTION

# HPRC1300



## FEATURES

- Removable multiformat memory card holder
- Accepted card Formats: SD, Memory stick, Memory stick pro duo, Mini SD
- Holds up to 2 memory cards per format
- Full/empty indicator

\* OPEN CASES IMAGES REFLECT THE DIFFERENT HPRC CASES INTERNAL OPTIONS

<b>Dimension:</b>	<b>internal dimension</b> 116x67x25(mm) - 4,57x2,66x1(in)
	<b>external dimension</b> 127,5x90x32(mm) - 5,01x3,54x1,25(in)
	<b>lid:</b> 12,8(mm) - 0,50(in) <b>bottom:</b> 12,20(mm) - 1,24(in)
<b>Weight:</b>	<b>empty:</b> 0,086 kg - 0,189 lbs <b>available empty or with memory card storage</b>
<b>Temperature rating:</b>	Minimum                      Maximum -40°C -40°F                      +80°C +176°F
<b>Colors:</b>	Black - Ferrari red



## TECHNICAL DRAWING

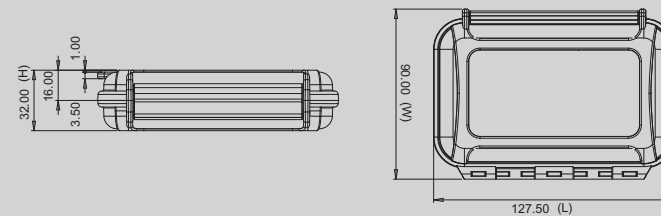

## APPROVALS

ATA 300  
IP67  
STANAG 4280  
DS 81-41

## TEST

DROP  
IMPACT  
HANDLE  
WATERTIGHT INTEGRITY  
UV COLOR AND MATERIAL PROTECTION

# HPRC2100



\* CUBED FOAM



\* CORDURA BAG

## ACCESSORIES

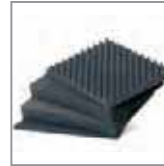

HPRCCF2100 CUBED FOAM  
USA:HPRCF0 (FOAM ONLY)



HPRCL0 PADLOCK - TSA



HPRCCB2100 CORDURA BAG  
USA:HPRIC (INTERNAL CASE)



HPRCPANELFRAME

\* OPEN CASES IMAGES REFLECT THE DIFFERENT HPRC CASES INTERNAL OPTIONS

**Dimension:** **internal dimension**  
215x150x95(mm) - 8,46x5,91x3,74(in)  
**external dimension**  
235x190x105(mm) - 9,26x7,48x4,13(in)

**lid:** 19(mm) - 0,75(in) **bottom:** 76(mm) - 2,99(in)

**Weight:** **empty:** 0,70kg - 1,54lbs  
**with cubed foam:** 0,84kg - 1,85lbs

**Temperature rating:** Minimum Maximum  
-40°C -40°F +80°C +176°F

**Colors:** Black - Orange  
Ferrari red - Electric blue



## TECHNICAL DRAWING

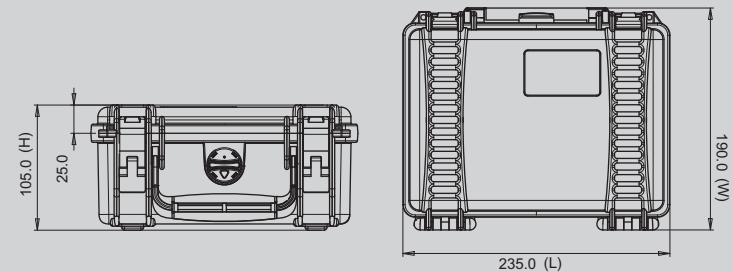

VOLUME IN LITRES  
WHEELED

## APPROVALS

ATA 300  
IP67  
STANAG 4280  
DS 81-41

## TEST

DROP  
IMPACT  
HANDLE  
WATERTIGHT INTEGRITY  
UV COLOR AND MATERIAL PROTECTION



# HPRC2200



\* CUBED FOAM



\* CORDURA BAG

## ACCESSORIES



HPRCCF2200 CUBED FOAM  
USA:HPRCFO (FOAM ONLY)



HPRCLO PADLOCK - TSA



HPRCCB2200 CORDURA BAG  
USA:HPRCIC (INTERNAL CASE)



HPRCPANELFRAME

\* OPEN CASES IMAGES REFLECT THE DIFFERENT HPRC CASES INTERNAL OPTIONS

**Dimension:** **internal dimension**  
236x182x105(mm) - 9,30x7,16x4,13(in)  
**external dimension**  
258x230x120(mm) - 10,15x9,05x4,72(in)

**lid:** 29(mm) - 1,14(in) **bottom:** 76(mm) - 2,99(in)



**Weight:** **empty:** 0,87kg - 1,92lbs  
**with cubed foam:** 1,08kg - 2,38lbs

**Temperature rating:** Minimum -40°C -40°F Maximum +80°C +176°F

**Colors:** Black

## TECHNICAL DRAWING

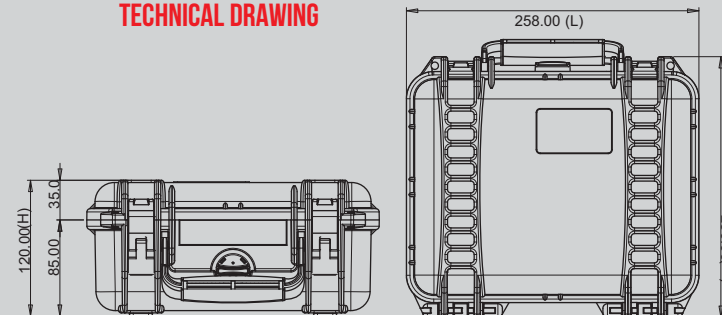

11.1 L VOLUME IN LITRES

W WHEELED

## APPROVALS

ATA 300  
IP67  
STANAG 4280  
DS 81-41

## TEST

DROP  
IMPACT  
HANDLE  
WATERTIGHT INTEGRITY  
UV COLOR AND MATERIAL PROTECTION



# HPRC2250



## ACCESSORIES

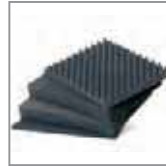

HPRCCF2550 CUBED FOAM  
USA:HPRCFO (FOAM ONLY)



HPRCLO PADLOCK - TSA



HPRCCB2550 CORDURA BAG  
USA:HPRCIC (INTERNAL CASE)



HPRCPANELFRAME

\* OPEN CASES IMAGES REFLECT THE DIFFERENT HPRC CASES INTERNAL OPTIONS

**Dimension:** **internal dimension**  
236x182x155(mm) - 9,30x7,16x6,10(in)  
**external dimension**  
258x230x170 (mm) - 10,15x9,05x6,70(in)

**lid:** 29(mm) - 1,14(in) **bottom:** 126(mm) - 4,96(in)

**Weight:** **empty:** 1,0kg - 2,2lbs  
**with cubed foam:** 1,35kg - 2,97lbs

**Temperature rating:** Minimum -40°C -40°F Maximum +80°C +176°F

**Colors:** Black



## TECHNICAL DRAWING

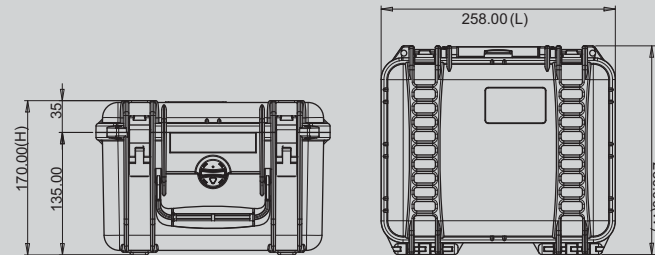

## APPROVALS

ATA 300  
IP67  
STANAG 4280  
DS 81-41

## TEST

DROP  
IMPACT  
HANDLE  
WATERTIGHT INTEGRITY  
UV COLOR AND MATERIAL PROTECTION

# HPRC2300



\* CUBED FOAM



\* CORDURA BAG

## ACCESSORIES



HPRCCF2300 CUBED FOAM  
USA:HPRCFO (FOAM ONLY)



HPRCLO PADLOCK - TSA



HPRCCB2300 CORDURA BAG  
USA:HPRCIC (INTERNAL CASE)



HPRCPANELFRAME

\* OPEN CASES IMAGES REFLECT THE DIFFERENT HPRC CASES INTERNAL OPTIONS

**Dimension:**

<b>internal dimension</b>	305x230x137(mm) - 12,00x9,06x5,39(in)	
<b>external dimension</b>	335x290x155(mm) - 13,19x11,42x6,10(in)	

**lid:** 31(mm) - 1,22(in) **bottom:** 106(mm) - 4,17(in)

**Weight:**

<b>empty:</b>	1,67kg - 3,68lbs
<b>with cubed foam:</b>	1,90kg - 4,19lbs

**Temperature rating:**

<b>Minimum</b>	-40°C -40°F	<b>Maximum</b>	+80°C +176°F
----------------	-------------	----------------	--------------

**Colors:** Black - Orange  
Ferrari red - Electric blue



## TECHNICAL DRAWING

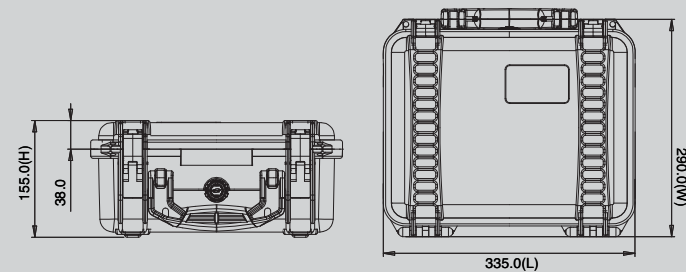

## APPROVALS

ATA 300  
IP67  
STANAG 4280  
DS 81-41

## TEST

DROP  
IMPACT  
HANDLE  
WATERTIGHT INTEGRITY  
UV COLOR AND MATERIAL PROTECTION



# HPRC2400



\* CUBED FOAM



\* CORDURA BAG

## ACCESSORIES

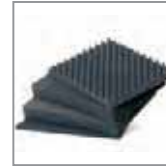

HPRCCF2400 CUBED FOAM  
USA:HPRCF0 (FOAM ONLY)



HPRCLD PADLOCK - TSA



HPRCB2400 CORDURA BAG  
USA:HPRIC (INTERNAL CASE)



HPRCSTRAP



HPRCORG2400 LID ORGANIZER



HPRCPANELFRAME

\* OPEN CASES IMAGES REFLECT THE DIFFERENT HPRC CASES INTERNAL OPTIONS

**Dimension:** **internal dimension**  
375x265x152(mm) - 14,76x10,43x5,98(in)  
**external dimension**  
405x330x165(mm) - 15,94x12,99x6,50(in)



**lid:** 45(mm) - 1,77(in) **bottom:** 107(mm) - 4,21(in)

**Weight:** **empty:** 2,05kg - 4,51lbs  
**with cubed foam:** 2,38kg - 5,25lbs

**Temperature rating:** Minimum Maximum  
-40°C -40°F +80°C +176°F

**Colors:** Black - Orange  
Ferrari red - Electric blue

## TECHNICAL DRAWING

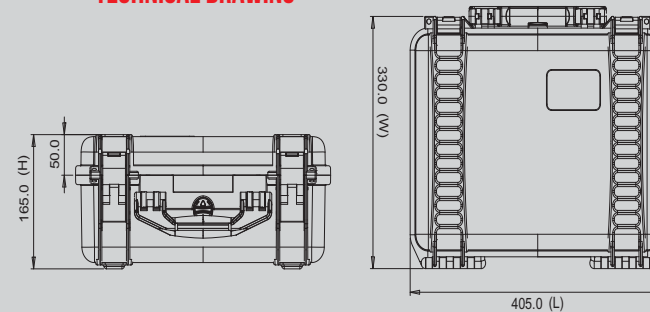

## APPROVALS

ATA 300  
IP67  
STANAG 4280  
DS 81-41

## TEST

DROP  
IMPACT  
HANDLE  
WATERTIGHT INTEGRITY  
UV COLOR AND MATERIAL PROTECTION





# HPRC2460



\* CUBED FOAM



\* CORDURA BAG

## ACCESSORIES



HPRCCF2460 CUBED FOAM  
USA:HPRCF0 (FOAM ONLY)



HPRCLD PADLOCK - TSA



HPRCCB2460 CORDURA BAG  
USA:HPRCIC (INTERNAL CASE)



HPRCORG2460 LID  
ORGANIZER



HPRCPANELFRAME

\* OPEN CASES IMAGES REFLECT THE DIFFERENT HPRC CASES INTERNAL OPTIONS

**Dimension:** **internal dimension**  
409x306x175(mm) - 16,10x12,04x6,89(in)  
**external dimension**  
434x377x188(mm) - 17,08x14,84x7,40(in)



**lid:** 70(mm) - 2,75(in) **bottom:** 105(mm) - 4,14(in)

**Weight:** **empty:** 2,60kg - 5,73lbs  
**with cubed foam:** 3,14 kg - 6,92 lbs

**Temperature rating:** Minimum Maximum  
-40°C -40°F +80°C +176°F

**Colors:** Black

## TECHNICAL DRAWING

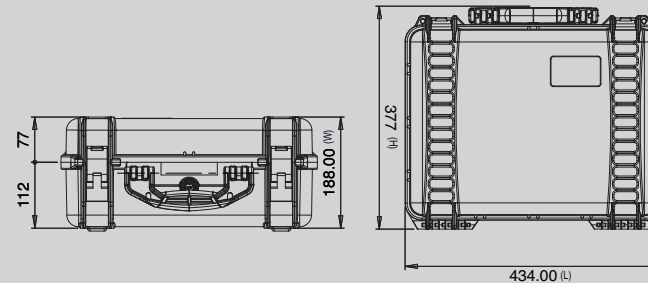

## APPROVALS

ATA 300  
IP67  
STANAG 4280  
DS 81-41

## TEST

DROP  
IMPACT  
HANDLE  
WATERTIGHT INTEGRITY  
UV COLOR AND MATERIAL PROTECTION



# HPRC2500



## ACCESSORIES



HPRCCF2500 CUBED FOAM  
USA:HPRCFO (FOAM ONLY)



HPRCLO PADLOCK - TSA



HPRCCB2500 CORDURA BAG  
USA:HPRCIC (INTERNAL CASE)



HPRCPANELFRAME



HPRCSTRAP



HPRCSD2500 SOFT PADDED OPEN DECK ±  
DIVIDERS USA:HPRCDK (DIVIDER KIT)



HPRCORG2500 LID ORGANIZER

\* OPEN CASES IMAGES REFLECT THE DIFFERENT HPRC CASES INTERNAL OPTIONS

**Dimension:** **internal dimension**  
450x320x175(mm) - 17,72x12,60x6,89(in)  
**external dimension**  
480x385x190(mm) - 18,90x15,16x7,48(in)

**lid:** 46(mm) - 1,81(in) **bottom:** 129(mm) - 5,08(in)



**Weight:** **empty:** 3,15kg - 6,95lbs  
**with cubed foam:** 3,71kg - 8,18lbs

**Temperature rating:** Minimum -40°C -40°F Maximum +80°C +176°F

**Colors:** Black - Orange  
Ferrari red - Electric blue

## TECHNICAL DRAWING

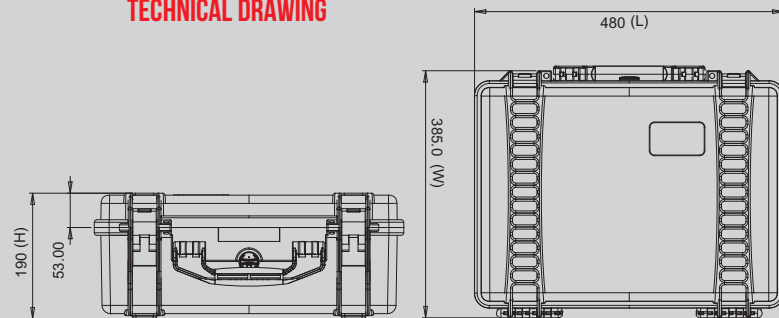

## APPROVALS

ATA 300  
IP67  
STANAG 4280  
DS 81-41

## TEST

DROP  
IMPACT  
HANDLE  
WATERTIGHT INTEGRITY  
UV COLOR AND MATERIAL PROTECTION



# HPRC4050

**SHOULDER CASE**



\* CUBED FOAM



\* SOFT PADDED OPEN DECK + DIVIDERS

## ACCESSORIES



HPRCCF4050 CUBED FOAM  
USA: HPRCFO (FOAM ONLY)



HPRCLO PADLOCK - TSA



HPRCPADEDSTRAP



HPRCSD4050 SOFT PADDED OPEN DECK + DIVIDERS  
USA: HPRCDK (DIVIDER KIT)

\* OPEN CASES IMAGES REFLECT THE DIFFERENT HPRC CASES INTERNAL OPTIONS

**Dimension:**  
**internal dimension**  
 261x220x171 (mm) - 10,27x8,66x6,73(in)  
**external dimension**  
 284x260x223 (mm) - 11,18x10,23x8,78(in)



**lid:** 46(mm) - 1,81 (in) **bottom:** 174(mm) - 6,85(in)

**Weight:**  
**empty:** 1,6kg - 3,1lbs  
**with cubed foam:** 1,85kg - 4,07lbs

**Temperature rating:**  
 Minimum -40°C -40°F      Maximum +80°C +176°F

**Colors:** Black

## TECHNICAL DRAWING

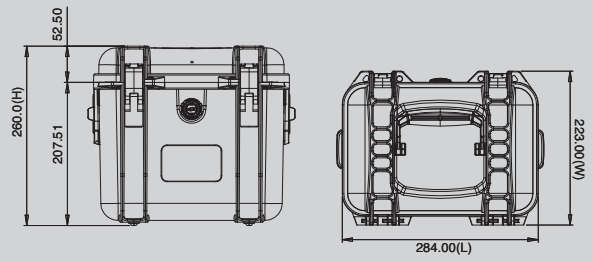

**11 L** VOLUME IN LITRES  
**W** WHEELED

**APPROVALS**  
 ATA 300  
 IP67  
 STANAG 4280  
 DS 81-41

**TEST**  
 DROP  
 IMPACT  
 HANDLE  
 WATERTIGHT INTEGRITY  
 UV COLOR AND MATERIAL PROTECTION



# HPRC4100

**SHOULDER CASE**



\* CUBED FOAM



\* SOFT PADDED OPEN DECK + DIVIDERS - LID LAPTOP BAG SOLD SEPARATELY

## ACCESSORIES



HPRCCF4100 CUBED FOAM  
USA:HPRCFO (FOAM ONLY)



HPRCLO PADLOCK - TSA



HPRCPADDEDSTRAP



HPRCSD4100 SOFT PADDED OPEN DECK + DIVIDERS USA:HPRCDK (DIVIDER KIT)

\* OPEN CASES IMAGES REFLECT THE DIFFERENT HPRC CASES INTERNAL OPTIONS

<b>Dimension:</b>	<b>internal dimension</b>	401x231x231(mm) - 15,78x9,09x9,09(in)
	<b>external dimension</b>	424x276,5x284(mm) - 16,70x10,88x11,18(in)
	<b>lid:</b> 46(mm) - 1,81(in) <b>bottom:</b> 185(mm) - 7,28(in)	
<b>Weight:</b>	<b>empty:</b>	2,78kg - 5,25lbs
	<b>with cubed foam:</b>	3,27kg - 7,20lbs
<b>Temperature rating:</b>	<b>Minimum</b>	-40°C -40°F
	<b>Maximum</b>	+80°C +176°F
<b>Colors:</b>	Black	



## TECHNICAL DRAWING

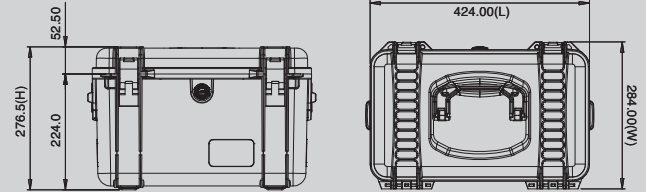

## APPROVALS

- ATA 300
- IP67
- STANAG 4280
- DS 81-41

## TEST

- DROP
- IMPACT
- HANDLE
- WATERTIGHT INTEGRITY
- UV COLOR AND MATERIAL PROTECTION



# HPRC2530



\* CUBED FOAM



\* SOFT PADDED OPEN DECK + DIVIDERS

## ACCESSORIES



HPRCCF2530 CUBED FOAM  
USA:HPRCFO (FOAM ONLY)



HPRCLO  
PADLOCK - TSA



HPRCSTRAP



HPRCSD2530 SOFT PADDED OPEN DECK +  
DIVIDERS USA:HPRCDK (DIVIDER KIT)

\* OPEN CASES IMAGES REFLECT THE DIFFERENT HPRC CASES INTERNAL OPTIONS

Dimension:	internal dimension	513x288x132(mm) - 20.2x11.34x5.20(in)	
	external dimension	540x350x153(mm) - 21.26x13.78x6.02(in)	
	lid:	46(mm) - 1.81(in)	bottom: 86(mm) - 3.25(in)
Weight:	empty:	2.80kg - 6.17lbs	
	with cubed foam:	3.26kg - 7.19lbs	
Temperature rating:	Minimum	-40°C	-40°F
	Maximum	+80°C	+176°F
Colors:	Black		



## TECHNICAL DRAWING

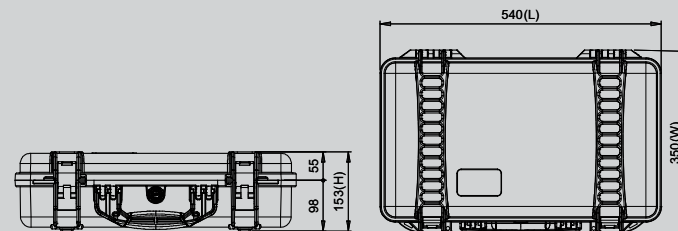

## APPROVALS

ATA 300  
IP67  
STANAG 4280  
DS 81-41

## TEST

DROP  
IMPACT  
HANDLE  
WATERTIGHT INTEGRITY  
UV COLOR AND MATERIAL PROTECTION



# HPRC2550W



\* CUBED FOAM



\* CORDURA BAG



\* SOFT PADDED OPEN DECK + DIVIDERS

## ACCESSORIES



HPRCCF2550W CUBED FOAM  
USA: HPRCFO (FOAM ONLY)



HPRCLO  
PADLOCK - TSA



HPRCCB2550W CORDURA BAG  
USA: HPRCIC (INTERNAL CASE)



HPRCSTRAP



HPRCORG2550W  
LID ORGANIZER



HPRCSD2550W SOFT PADDED OPEN DECK +  
DIVIDERS USA: HPRCDK (DIVIDER KIT)

\* OPEN CASES IMAGES REFLECT THE DIFFERENT HPRC CASES INTERNAL OPTIONS

Dimension:	internal dimension	510x285x199(mm) - 20,08x11,22x7,83(in)	W	it29	CABIN OK
	external dimension	545x350x230(mm) - 21,46x13,78x9,05(in)			
	lid: 46(mm) - 1,81(in)	bottom: 153(mm) - 6,02(in)			
Weight:	empty:	4,85kg - 10,67lbs			
	with cubed foam:	5,35kg - 11,79lbs			
Temperature rating:	Minimum	-40°C -40°F			
	Maximum	+80°C +176°F			
Colors:	Black - Orange	Ferrari red - Electric blue			

## TECHNICAL DRAWING

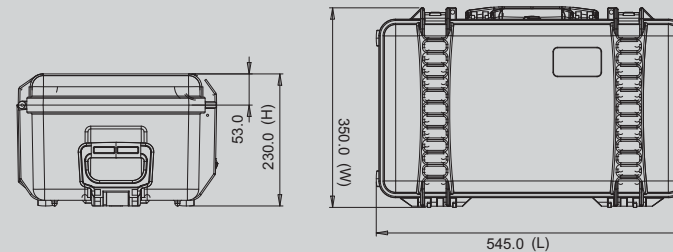

it1 VOLUME IN LITRES  
W WHEELED

## APPROVALS

ATA 300  
IP67  
STANAG 4280  
DS 81-41

## TEST

DROP  
IMPACT  
HANDLE  
WATERTIGHT INTEGRITY  
UV COLOR AND MATERIAL PROTECTION



# HPRC2580



\* CUBED FOAM



\* ADV



## ACCESSORIES

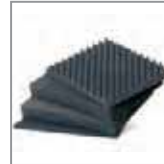

HPRCCF2550W CUBED FOAM  
USA:HPRCF0 (FOAM ONLY)



HPRCLO  
PADLOCK - TSA



HPRCSTRAP



HPRCORG2580  
LID ORGANIZER

\* OPEN CASES IMAGES REFLECT THE DIFFERENT HPRC CASES INTERNAL OPTIONS

**Dimension:** **internal dimension**  
390x310x89(mm) - 15,35x12,20x3,50(in)  
**external dimension**  
411x359x110(mm) - 16,18x14,13x4,33(in)

**lid:** 44(mm) - 1,73(in) **bottom:** 45(mm) - 1,77(in)

**Weight:** **empty:** 2,40kg - 5,28lbs  
**with cubed foam:** 2,57kg - 5,67lbs

**Temperature rating:** Minimum -40°C -40°F Maximum +80°C +176°F

**Colors:** Black

on the go pocket



## TECHNICAL DRAWING

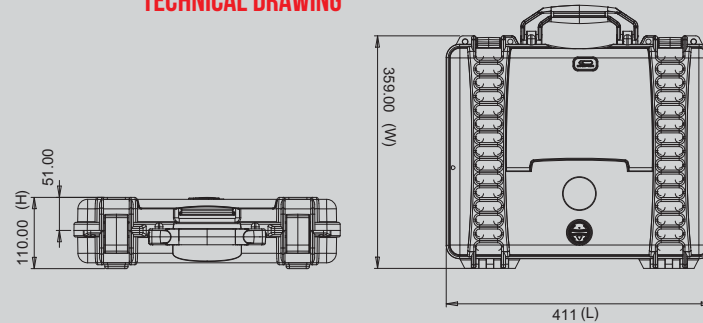

## APPROVALS

ATA 300  
IP67  
STANAG 4280  
DS 81-41

## TEST

DROP  
IMPACT  
HANDLE  
WATERTIGHT INTEGRITY  
UV COLOR AND MATERIAL PROTECTION



# HPRC3500



\* CUBED FOAM



\* CORDURA BAG



## ACCESSORIES



HPRCCF3500 CUBED FOAM  
USA: HPRCFO (FOAM ONLY)



HPRCCB3500 CORDURA BAG  
USA: HPRCIC (INTERNAL CASE)



HPRCSTRAP



HPRCORG3500  
LID ORGANIZER



\*CUSTOMIZED PRODUCT IMAGE

\* OPEN CASES IMAGES REFLECT THE DIFFERENT HPRC CASES INTERNAL OPTIONS

<b>Dimension:</b>	<b>internal dimension</b> 430x320x160(mm) - 16.92x12.59x6.29(in)
	<b>external dimension</b> 500x370x185(mm) - 16.98x14.56x7.28(in)
	<b>lid:</b> 72 (mm) – 2,83 (in) <b>bottom:</b> 88(mm) - 3,46(in)
<b>Weight:</b>	<b>empty:</b> 3,00kg - 6,61lbs
	<b>with cubed foam:</b> 3,55kg - 7,82lbs
<b>Temperature rating:</b>	Minimum                      Maximum
	-40°C -40°F                      +80°C +176°F
<b>Colors:</b>	Black



## TECHNICAL DRAWING

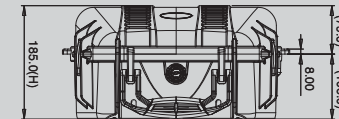
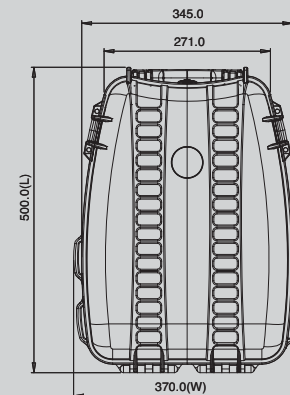

## APPROVALS

ATA 300  
IP67  
STANAG 4280  
DS 81-41

## TEST

DROP  
IMPACT  
HANDLE  
WATERTIGHT INTEGRITY  
UV COLOR AND MATERIAL PROTECTION





# HPRC4300



## ACCESSORIES



HPRCCF4300 CUBED FOAM  
USA: HPRCFO (FOAM ONLY)



HPRCDB4300 CORDURA BAG  
USA: HPRCIC (INTERNAL CASE)



HPRCLO  
PADLOCK - TSA



HPRCSD4300 SOFT PADDED OPEN DECK \*  
DIVIDERS USA: HPRCDK (DIVIDER KIT)

\* OPEN CASES IMAGES REFLECT THE DIFFERENT HPRC CASES INTERNAL OPTIONS

Dimension:	internal dimension	585x320x309(mm) - 23,03x12,60x12,16(in)	
	external dimension	690x380x355(mm) - 27,16x14,96x13,98(in)	
	lid: 88(mm) - 3,46(in)	bottom:	268(mm) - 10,55(in)
Weight:	empty:	6,5kg - 14,3lbs	
	with cubed foam:	7,96kg - 17,54 lbs	
Temperature rating:	Minimum	-40°C	-40°F
	Maximum	+80°C	+176°F
Colors:	Black		



## TECHNICAL DRAWING

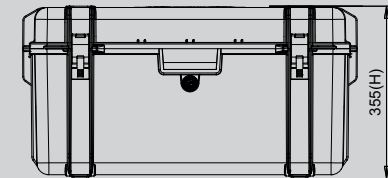
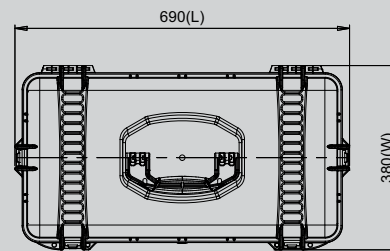

## APPROVALS

ATA 300  
IP67  
STANAG 4280  
DS 81-41

## TEST

DROP  
IMPACT  
HANDLE  
WATERTIGHT INTEGRITY  
UV COLOR AND MATERIAL PROTECTION

# HPRC4300W



## ACCESSORIES



HPRCCF4300W CUBED FOAM  
USA:HPRCFO (FOAM ONLY)



HPRCB4300W CORDURA BAG  
USA:HPRCIC (INTERNAL CASE)



HPRCLO  
PADLOCK - TSA



HPRCSD4300W SOFT PADDED OPEN DECK ±  
DIVIDERS USA:HPRCDK (DIVIDER KIT)

\* OPEN CASES IMAGES REFLECT THE DIFFERENT HPRC CASES INTERNAL OPTIONS

Dimension:	internal dimension	585x320x300(mm) - 23,03x12,60x11,81 (in)
	external dimension	690x380x358(mm) - 27,16x14,96x14,10 (in)
	lid: 88(mm) - 3,46(in)	bottom: 271(mm) - 10,66(in)
Weight:	empty:	7,3kg - 16,1lbs
	with cubed foam:	8,76kg - 19,31lbs
Temperature rating:	Minimum	-40°C -40°F
	Maximum	+80°C +176°F
Colors:	Black	



## TECHNICAL DRAWING

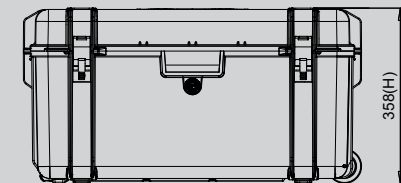
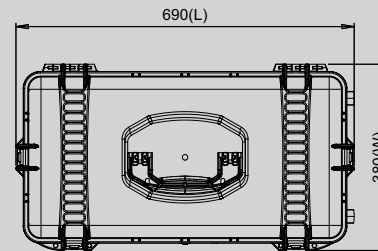

## APPROVALS

ATA 300  
IP67  
STANAG 4280  
DS 81-41

## TEST

DROP  
IMPACT  
HANDLE  
WATERTIGHT INTEGRITY  
UV COLOR AND MATERIAL PROTECTION

# HPRC2600



## ACCESSORIES



HPRCCF2600 CUBED FOAM  
USA: HPRCFO (FOAM ONLY)



HPRCLO  
PADLOCK - TSA



HPRCCB2600 CORDURA BAG  
USA: HPRCIC (INTERNAL CASE)



HPRCPANELFRAME



HPRCSTRAP



HPRCORG2600  
LID ORGANIZER



HPRCSD2600 SOFT PADDED OPEN DECK ≠  
DIVIDERS USA: HPRCDK (DIVIDER KIT)

\* OPEN CASES IMAGES REFLECT THE DIFFERENT HPRC CASES INTERNAL OPTIONS

Dimension:	internal dimension	480x360x198(mm) - 18,90x14,17x7,79(in)	
	external dimension	550x420x215(mm) - 21,65x16,53x8,46(in)	
	lid:	46(mm) - 1,81(in)	bottom: 152(mm) - 5,98(in)
Weight:	empty:	4,25kg - 9,37lbs	
	with cubed foam:	5,05kg - 11,13lbs	
Temperature rating:	Minimum	-40°C	-40°F
	Maximum	+80°C	+176°F
Colors:	Black - Orange		
	Ferrari red - Electric blue		



## TECHNICAL DRAWING

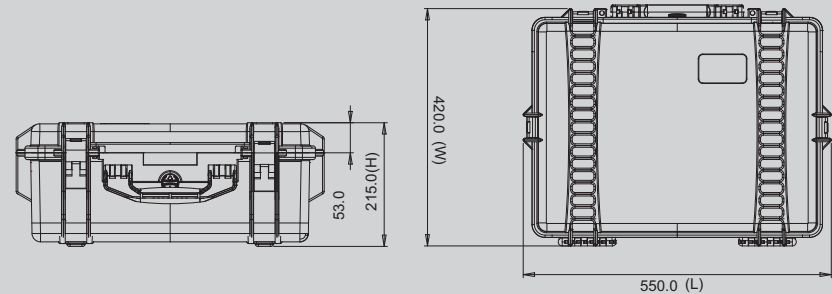

**APPROVALS**  
ATA 300  
IP67  
STANAG 4280  
DS 81-41

**TEST**  
DROP  
IMPACT  
HANDLE  
WATERTIGHT INTEGRITY  
UV COLOR AND MATERIAL PROTECTION



# HPRC2600W



## ACCESSORIES

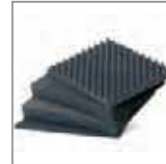

HPRCCF2600W CUBED FOAM  
USA:HPRCF0 (FOAM ONLY)



HPRCLO  
PADLOCK - TSA



HPRCCB2600W CORDURA BAG  
USA:HPRCIC (INTERNAL CASE)



HPRCSTRAP



HPRCORG2600W  
LID ORGANIZER



HPRCSD2600W SOFT PADDED OPEN DECK ±  
DIVIDERS USA:HPRCDK (DIVIDER KIT)

\* OPEN CASES IMAGES REFLECT THE DIFFERENT HPRC CASES INTERNAL OPTIONS

Dimension:	internal dimension	484x360x218(mm) - 19,05x14,17x8,58(in)
	external dimension	550x420x260(mm) - 21,65x16,53x10,24(in)
	lid: 46(mm) - 1,81(in) bottom: 172(mm) - 6,77(in)	
Weight:	empty:	6,05kg - 13,34lbs
	with cubed foam:	6,97kg - 15,37lbs
Temperature rating:	Minimum	-40°C -40°F
	Maximum	+80°C +176°F
Colors:	Black - Orange - Electric blue	



## TECHNICAL DRAWING

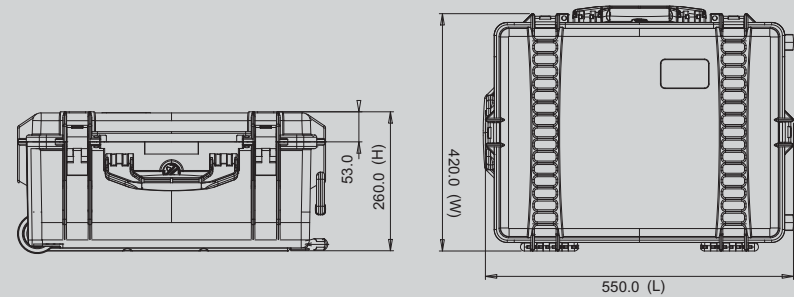

## APPROVALS

ATA 300  
IP67  
STANAG 4280  
DS 81-41

## TEST

DROP  
IMPACT  
HANDLE  
WATERTIGHT INTEGRITY  
UV COLOR AND MATERIAL PROTECTION



# HPRC2700



\* CUBED FOAM

\* CORDURA BAG

\* SOFT PADDED OPEN DECK + DIVIDERS

## ACCESSORIES

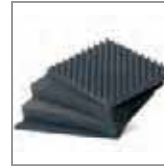

HPRCCF2700 CUBED FOAM  
USA: HPRCF0 (FOAM ONLY)



HPRCLO  
PADLOCK - TSA



HPRCCB2700 CORDURA BAG  
USA: HPRIC (INTERNAL CASE)



HPRCSTRAP



HPRCORG2700  
LID ORGANIZER



HPRCSD2700 SOFT PADDED OPEN DECK +  
DIVIDERS USA: HPRCDK (DIVIDER KIT)

\* OPEN CASES IMAGES REFLECT THE DIFFERENT HPRC CASES INTERNAL OPTIONS

<b>Dimension:</b>	<b>internal dimension</b> 550x460x205(mm) - 21,65x18,11x8,07(in)
	<b>external dimension</b> 590x525x225(mm) - 23,23x20,67x8,86(in)
	<b>lid:</b> 45(mm) - 1,77(in) <b>bottom:</b> 160(mm) - 6,03(in)
<b>Weight:</b>	<b>empty:</b> 5,55kg - 12,24lbs
	<b>with cubed foam:</b> 6,71kg - 14,79lbs
<b>Temperature rating:</b>	Minimum -40°C -40°F
	Maximum +80°C +176°F
<b>Colors:</b>	Black - Orange - Ferrari red



## TECHNICAL DRAWING

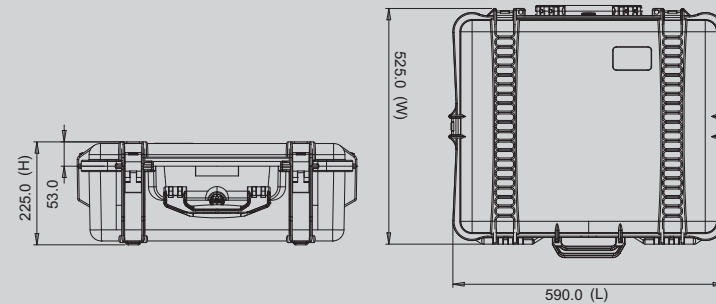

## APPROVALS

ATA 300  
IP67  
STANAG 4280  
DS 81-41

## TEST

DROP  
IMPACT  
HANDLE  
WATERTIGHT INTEGRITY  
UV COLOR AND MATERIAL PROTECTION



# HPRC2700W



\* CUBED FOAM



\* CORDURA BAG



\* SOFT PADDED OPEN DECK + DIVIDERS

## ACCESSORIES



HPRCCF2700W CUBED FOAM  
USA:HPRCFO (FOAM ONLY)



HPRCLO  
PADLOCK - TSA



HPRCCB2700W CORDURA BAG  
USA:HPRCIC (INTERNAL CASE)



HPRCSD2700W SOFT PADDED OPEN DECK ±  
DIVIDERS USA:HPRCDK (DIVIDER KIT)



HPRCORG2700W  
LID ORGANIZER

\* OPEN CASES IMAGES REFLECT THE DIFFERENT HPRC CASES INTERNAL OPTIONS

Dimension:	internal dimension	555x460x256(mm) - 21,85x18,1x10,08(in)
	external dimension	620x520x275(mm) - 24,41x20,47x10,83(in)
	lid: 46(mm) - 1,81(in)	bottom: 210(mm) - 8,27(in)
Weight:	empty:	7,55kg - 16,65lbs
	with cubed foam:	9,07kg - 19,99lbs
Temperature rating:	Minimum	-40°C -40°F
	Maximum	+80°C +176°F
Colors:	Black - Orange - Ferrari red - Yellow	



## TECHNICAL DRAWING

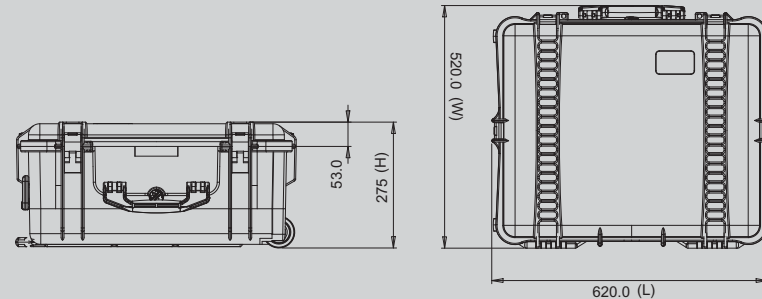

**APPROVALS**  
ATA 300  
IP67  
STANAG 4280  
DS 81-41

**TEST**  
DROP  
IMPACT  
HANDLE  
WATERTIGHT INTEGRITY  
UV COLOR AND MATERIAL PROTECTION



# HPRC2730W



\* CUBED FOAM



\* CORDURA BAG



\* SOFT PADDED OPEN DECK + DIVIDERS



## ACCESSORIES

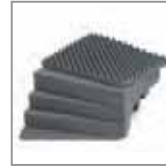

HPRCCF2730W CUBED FOAM  
USA:HPRCF0 (FOAM ONLY)



HPRCL0  
PADLOCK - TSA



HPRCCB2730W CORDURA BAG  
USA:HPRCIC (INTERNAL CASE)



HPRCSD2730W SOFT PADDED OPEN DECK +  
DIVIDERS USA:HPRCDK (DIVIDER KIT)



HPRCORG2730W  
LID ORGANIZER

\* OPEN CASES IMAGES REFLECT THE DIFFERENT HPRC CASES INTERNAL OPTIONS

Dimension:	internal dimension	509x460x316(mm) - 20.04x18.11x 12.44(in)
	external dimension	620x350x520(mm) - 24.41x20.47x13.78(in)
	lid: 53(mm) - 2,08(in)	bottom: 270(mm) - 10,62(in)
Weight:	empty:	8,3kg - 18,3lbs
	with cubed foam:	10,43 kg - 22,99lbs
Temperature rating:	Minimum	-40°C -40°F
	Maximum	+80°C +176°F
Colors:	Black	



## TECHNICAL DRAWING

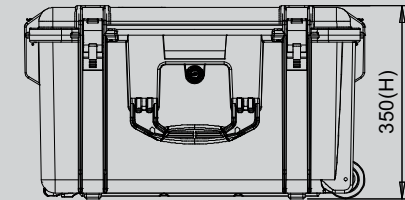
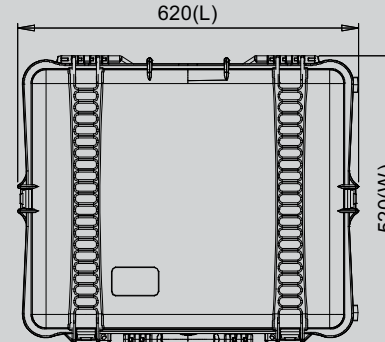

## APPROVALS

ATA 300  
IP67  
STANAG 4280  
DS 81-41

## TEST

DROP  
IMPACT  
HANDLE  
WATERTIGHT INTEGRITY  
UV COLOR AND MATERIAL PROTECTION



# HPRC6300W



**HOW IT WORKS**



\* TRI VERSION



\* CUBED FOAM



## ACCESSORIES



HPRCCF6300W CUBED FOAM  
USA:HPRCF0 (FOAM ONLY)



HPRC6300WTRI FOR TRIPODS

\* OPEN CASES IMAGES REFLECT THE DIFFERENT HPRC CASES INTERNAL OPTIONS

<b>Dimension:</b>	<b>internal dimension</b> 925x270x243(mm) - 36,42x10,63x9,56(in)	<b>lit 54</b>
	<b>external dimension</b> 970x285x335(mm) - 38,19x11,22x13,19(in)	
	<b>lid:</b> 140(mm) - 5,51(in) <b>bottom:</b> 130(mm) - 5,11(in)	
<b>Weight:</b>	<b>empty:</b> 5,7kg - 12,57lbs <b>with cubed foam:</b> 6,95kg - 15,32lbs	
<b>Temperature rating:</b>	Minimum -40°C -40°F      Maximum +80°C +176°F	
<b>Colors:</b>	Black	

## TECHNICAL DRAWING

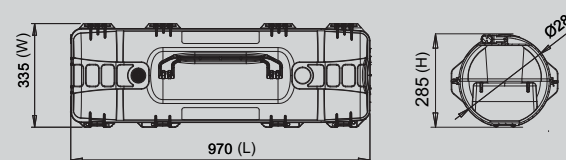

**lit 54** VOLUME IN LITRES  
**lit 54** WHEELED

## APPROVALS

ATA 300  
IP67  
STANAG 4280  
DS 81-41

## TEST

DROP  
IMPACT  
HANDLE  
WATERTIGHT INTEGRITY  
UV COLOR AND MATERIAL PROTECTION





# HPRC6400W



HOW IT WORKS



\* TRI VERSION



\* CUBED FOAM

## ACCESSORIES



HPRCCF6400W CUBED FOAM  
USA: HPRCF0 (FOAM ONLY)



HPRC6300WTRI FOR TRIPODS



\* TRIPOD NOT INCLUDED

\* OPEN CASES IMAGES REFLECT THE DIFFERENT HPRC CASES INTERNAL OPTIONS

Dimension:	internal dimension	1085x270x243(mm) - 42,72x10,63x9,56(in)
	external dimension	1130x285x335(mm) - 44,49x11,22x13,19(in)
	lid: 145(mm) - 5,71(in) bottom: 140(mm) - 5,51(in)	
Weight:	empty:	6,3kg - 13,89lbs
	with cubed foam:	7,84kg - 17,28lbs
Temperature rating:	Minimum	-40°C -40°F
	Maximum	+80°C +176°F
Colors:	Black	



## TECHNICAL DRAWING

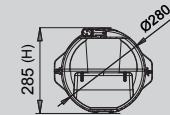
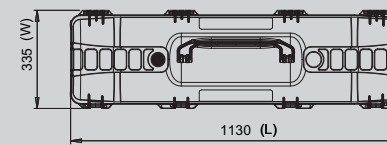

## APPROVALS

ATA 300  
IP67  
STANAG 4280  
DS 81-41

## TEST

DROP  
IMPACT  
HANDLE  
WATERTIGHT INTEGRITY  
UV COLOR AND MATERIAL PROTECTION



# HPRC6500W



**HOW IT WORKS**



## ACCESSORIES



HPRCCF6500W CUBED FOAM  
USA:HPRCF0 (FOAM ONLY)



HPRC6300WTRI FOR TRIPODS

\* OPEN CASES IMAGES REFLECT THE DIFFERENT HPRC CASES INTERNAL OPTIONS

<b>Dimension:</b>	<b>internal dimension</b> 1285x270x243(mm) - 50,59x10,63x9,56(in)	<b>lit 76</b>
	<b>external dimension</b> 1330x285x335(mm) - 52,36x11,22x13,19(in)	
	<b>lid:</b> 145(mm) - 5,71(in) <b>bottom:</b> 140(mm) - 5,50(in)	
<b>Weight:</b>	<b>empty:</b> 7,20kg - 15,87lbs	
	<b>with cubed foam:</b> 9,03kg - 19,90lbs	
<b>Temperature rating:</b>	<b>Minimum</b> -40°C -40°F	<b>Maximum</b> +80°C +176°F
<b>Colors:</b>	Black	

## TECHNICAL DRAWING

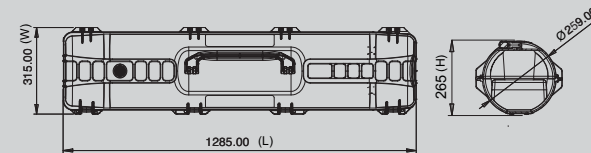

**lit 76** VOLUME IN LITRES  
**W** WHEELED

## APPROVALS

ATA 300  
IP67  
STANAG 4280  
DS 81-41

## TEST

DROP  
IMPACT  
HANDLE  
WATERTIGHT INTEGRITY  
UV COLOR AND MATERIAL PROTECTION



# HPRC2780W



\* CUBED FOAM



\* CORDURA BAG



\* SOFT PADDED OPEN DECK + DIVIDERS



## ACCESSORIES



HPRCCF2780W CUBED FOAM  
USA:HPRCFO (FOAM ONLY)



HPRCLO  
PADLOCK - TSA



HPRCSD2780W SOFT PADDED OPEN DECK +  
DIVIDERS USA:HPRCDK (DIVIDER KIT)



HPRCCB2780W CORDURA BAG  
USA:HPRCIC (INTERNAL CASE)



HPRCORG2780W  
LID ORGANIZER

\* OPEN CASES IMAGES REFLECT THE DIFFERENT HPRC CASES INTERNAL OPTIONS

**Dimension:** **internal dimension**  
745x525x366(mm) - 29,33x20,66x14,40(in)  
**external dimension**  
810x585x388(mm) - 31,86x23,00x15,27(in)

**lid:** 73(mm) - 2,87(in) **bottom:** 293(mm) - 11,53(in)

**Weight:** **empty:** 12,2kg - 26,89lbs  
**with cubed foam:** 16,18kg - 35,67lbs

**Temperature rating:** Minimum -40°C -40°F Maximum +80°C +176°F

**Colors:** Black



## TECHNICAL DRAWING

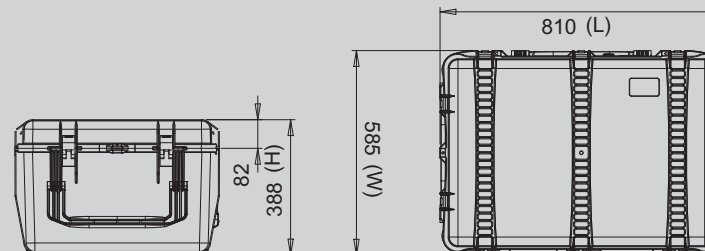

## APPROVALS

ATA 300  
IP67  
STANAG 4280  
DS 81-41

## TEST

DROP  
IMPACT  
HANDLE  
WATERTIGHT INTEGRITY  
UV COLOR AND MATERIAL PROTECTION



# HPRC2800W



\* CUBED FOAM



\* CORDURA BAG

## ACCESSORIES



HPRCCF2800W CUBED FOAM  
USA:HPRCF0 (FOAM ONLY)



HPRCLO  
PADLOCK - TSA



HPRCB2800W CORDURA BAG  
USA:HPRCIC (INTERNAL CASE)



HPRCORG2800W  
LID ORGANIZER

\* OPEN CASES IMAGES REFLECT THE DIFFERENT HPRC CASES INTERNAL OPTIONS

Dimension:	<b>internal dimension</b> 745x525x458(mm) - 29,30x20,65x18,01(in)
	<b>external dimension</b> 810x585x480(mm) - 31,86x23,00x18,88(in)
	<b>lid:</b> 73(mm) - 2,87(in) <b>bottom:</b> 385(mm) - 15,14(in)
Weight:	<b>empty:</b> 13,20kg - 29.1lbs
	<b>with cubed foam:</b> 17,43kg - 38.43lbs
Temperature rating:	Minimum -40°C -40°F
	Maximum +80°C +176°F
Colors:	Black



## TECHNICAL DRAWING

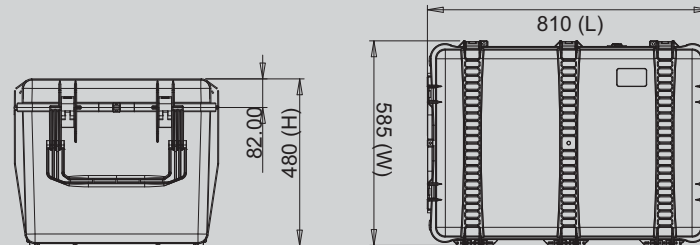

## APPROVALS

ATA 300  
IP67  
STANAG 4280  
DS 81-41

## TEST

DROP  
IMPACT  
HANDLE  
WATERTIGHT INTEGRITY  
UV COLOR AND MATERIAL PROTECTION



# HPRC4400



## ACCESSORIES

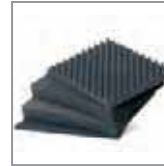

HPRCCF4400 CUBED FOAM  
USA:HPRCF0 (FOAM ONLY)



HPRCLO  
PADLOCK - TSA



HPRCKITW4400  
WHEEL KIT FOR 4400



\* OPEN CASES IMAGES REFLECT THE DIFFERENT HPRC CASES INTERNAL OPTIONS

<b>Dimension:</b>	<b>internal dimension</b>	420x420x420(mm) - 16,53x16,53x16,53(in)	
	<b>external dimension</b>	479x481x437(mm) - 18,86x18,94x17,20(in)	
	<b>lid:</b> 65(mm) - 2,56(in)	<b>bottom:</b> 355(mm) - 13,97(in)	
<b>Weight:</b>	<b>empty:</b> 6,70 - 14,77 lbs		
	<b>with cubed foam:</b> 8,90 - 19,62 lbs		
<b>Temperature rating:</b>	<b>Minimum</b>	-40°C -40°F	<b>Maximum</b>
			+80°C +176°F
<b>Colors:</b>	Black		



## TECHNICAL DRAWING

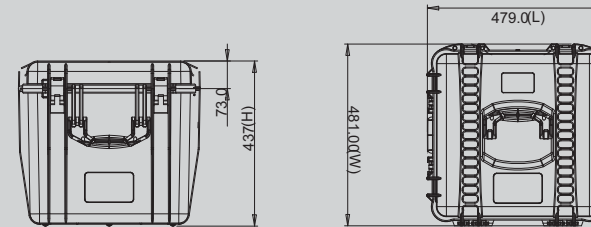

## APPROVALS

ATA 300  
IP67  
STANAG 4280  
DS 81-41

## TEST

DROP  
IMPACT  
HANDLE  
WATERTIGHT INTEGRITY  
UV COLOR AND MATERIAL PROTECTION

# HPRC5400W



\* CUBED FOAM



\* CORDURA BAG

## ACCESSORIES



HPRCCF5400W CUBED FOAM  
USA:HPRCFO (FOAM ONLY)



HPRCLO  
PADLOCK - TSA



HPRCCB5400W CORDURA BAG  
USA:HPRCIC (INTERNAL CASE)

\* OPEN CASES IMAGES REFLECT THE DIFFERENT HPRC CASES INTERNAL OPTIONS

**Dimension:** **internal dimension**  
1140x350x160(mm) - 44,90x13,78x6,30(in)  
**external dimension**  
1187x410x181(mm) - 46,73x16,07x7,12(in)



**lid:** 45(mm) - 1,77(in) **bottom:** 115(mm) - 4,52(in)

**Weight:** **empty:** 7,70kg - 16,94lbs  
**with cubed foam:** 8,80kg - 19,40lbs

**Temperature rating:** Minimum -40°C -40°F Maximum +80°C +176°F

**Colors:** Black

## TECHNICAL DRAWING

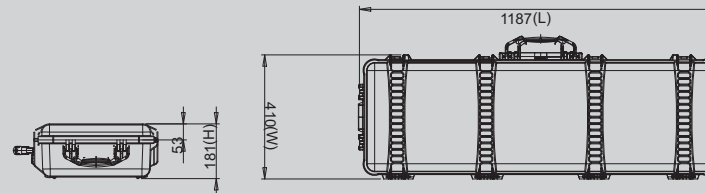

## APPROVALS

ATA 300  
IP67  
STANAG 4280  
DS 81-41

## TEST

DROP  
IMPACT  
HANDLE  
WATERTIGHT INTEGRITY  
UV COLOR AND MATERIAL PROTECTION



# HPRC0500



HOW IT WORKS



\* OPEN CASES IMAGES REFLECT THE DIFFERENT HPRC CASES INTERNAL OPTIONS



\* TRIPOD, LAPTOP AND SCHELTER NOT INCLUDED

**Dimension:** **closed**  
394x280x27,5(mm) - 15,51x11,02x1,08(in)  
**open**  
464x350x27,5(mm) - 18,26x13,77x1,08(in)

**Weight:** 0,95kg - 2,09lbs







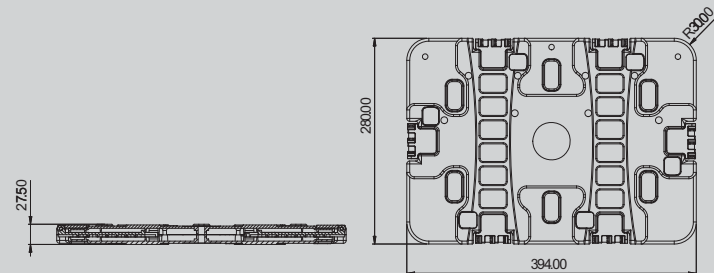























**Temperature rating:** Minimum -40°C -40°F      Maximum +80°C +176°F

**Colors:** Black

## TECHNICAL DRAWING









































# HPRC TECHNICAL CHART

NAME	MATERIAL	INTERNAL DIMENSION	EXTERNAL DIMENSION	VOLUME IN LITRES	WEIGHT EMPTY	WHEELS	COLORS
HPRC1100		58x57x25(mm) 2,28x2,26x1(in)	80x69x32(mm) 3,16x2,71x1,25(in)	 lt0,1	0,040kg 0,088lbs		Black Ferrari red
HPRC1300		116x67x25(mm) 4,57x2,66x1(in)	127x90x32(mm) 5,01x3,54x1,25(in)	 lt0,2	0,086 kg 0,189 lbs		Black Ferrari red
HPRC2100		215x150x95(mm) 8,46x5,91x3,74(in)	235x190x105(mm) 9,26x7,48x4,13(in)	 lt3	0,70kg 1,54lbs		Black - Orange Ferrari red - Electric blue
HPRC2200		236x182x105(mm) 9,30x7,16x4,13(in)	258x230x120(mm) 10,15x9,05x4,72(in)	 lt5	0,87kg 1,92lbs		Black
HPRC2250		236x182x155(mm) 9,30x7,16x6,10(in)	258x230x170 (mm) 10,15x9,05x6,70(in)	 lt7	1,0kg 2,2lbs		Black
HPRC2300		305x230x137(mm) 12,00x9,06x5,39(in)	335x290x155(mm) 13,19x11,42x6,10(in)	 lt10	1,67kg 3,68lbs		Black - Orange Ferrari red - Electric blue
HPRC2400		375x265x152(mm) 14,76x10,43x5,98(in)	405x330x165(mm) 15,94x12,99x6,50(in)	 lt15	2,05kg 4,51lbs		Black - Orange Ferrari red - Electric blue
HPRC2460		409x306x175(mm) 16,10x12,04x6,89(in)	434x377x188(mm) 17,08x14,84x7,40(in)	 lt21,5	2,60kg 5,73lbs		Black
HPRC2500		450x320x175(mm) 17,72x12,60x6,89(in)	480x385x190(mm) 18,90x15,16x7,48(in)	 lt25	3,15kg 6,95lbs		Black - Orange Ferrari red - Electric blue
HPRC4050		261x220x171(mm) 10,27x8,66x6,73(in)	284x260x223(mm) 11,18x10,23x8,78(in)	 lt10	1,6 (kg) 3,1 (lbs)		Black
HPRC4100		401x231x231(mm) 15,78x9,09x9,09(in)	424x276,5x284(mm) 16,70x10,88x11,18(in)	 lt22	2,78kg 5,25lbs		Black
HPRC2530		510x285x199(mm) 20,08x11,22x7,83(in)	545x350x230(mm) 21,46x13,78x9,05(in)	 lt19	2,80kg 6,17lbs		Black
HPRC2550W		513x288x132(mm) 20,2x11,34x5,20(in)	540x350x153(mm) 21,26x13,78x6,02(in)	 lt29	4,85kg 10,67lbs		Black - Orange Ferrari red - Electric blue
HPRC2580		390x310x89(mm) 15,35x12,20x3,50(in)	411x359x110(mm) 16,18x14,13x4,33(in)	 lt11	2,40kg 5,28lbs		Black
HPRC3500		430x320x160(mm) 16,92x12,59x6,29(in)	500x370x185(mm) 16,98x14,56x7,28(in)	 lt22	3,00 (kg) 6,61 (lbs)		Black







NAME	MATERIAL	INTERNAL DIMENSION	EXTERNAL DIMENSION	VOLUME IN LITRES	WEIGHT EMPTY	WHEELS	COLORS
<b>HPRC4300</b>		585x320x309(mm) 23,03x12,60x12,16(in)	690x380x355(mm) 27,16x14,96x13,98(in)		6,5kg 14,3lbs		Black
<b>HPRC4300W</b>		585x320x300(mm) 23,03x12,60x11,81(in)	690x380x358(mm) 27,16x14,96x14,10(in)		7,3kg 16,1lbs		Black
<b>HPRC2600</b>		480x360x198(mm) 18,90x14,17x7,79(in)	550x420x215(mm) 21,65x16,53x8,46(in)		4,25kg 9,37lbs		Black - Orange Ferrari red - Electric blue
<b>HPRC2600W</b>		484x360x218(mm) 19,05x14,17x8,58(in)	550x420x260(mm) 21,65x16,53x10,24(in)		6,05kg 13,34lbs		Black - Orange Electric blue
<b>HPRC2700</b>		550x460x205(mm) 21,65x18,11x8,07(in)	590x525x225(mm) 23,23x20,67x8,86(in)		5,55kg 12,24lbs		Black - Orange Ferrari red - Electric blue
<b>HPRC2700W</b>		555x460x256(mm) 21,85x18,1x10,08(in)	620x520x275(mm) 24,41x20,47x10,83(in)		7,55kg 16,65lbs		Black Yellow Orange Ferrari red
<b>HPRC2730W</b>		509x460x316(mm) 20,04x18,11x12,44(in)	620x350x520(mm) 24,41x20,47x13,78(in)		8,3kg 18,3lbs		Black
<b>HPRC6300W</b>		925x270x243(mm) 36,42x10,63x9,56(in)	970x285x335(mm) 38,19x11,22x13,19(in)		5,70kg 10,71lbs		Black
<b>HPRC6400W</b>		1085x270x243(mm) 42,72x10,63x9,56(in)	1130x285x335(mm) 44,49x11,22x13,19(in)		6,3Kg 11,84lbs		Black
<b>HPRC6500W</b>		1285x270x243(mm) 50,59x10,63x9,56(in)	1330x285x335(mm) 52,36x11,22x13,19(in)		7,20kg 13,56lbs		Black
<b>HPRC2780W</b>		745x525x366(mm) 29,33x20,65x14,40(in)	810x585x388(mm) 31,86x23,00x15,27(in)		12,2kg 26,10lbs		Black
<b>HPRC2800W</b>		745x525x458(mm) 29,30x20,65x18,01(in)	810x585x480(mm) 31,86x23,00x18,88(in)		13,20kg 29,1lbs		Black
<b>HPRC4400</b>		420x420x420(mm) 16,53x16,53x16,53(in)	479x481x437(mm) 18,86x18,94x17,20(in)		7,5Kg 16,66lbs		Black
<b>HPRC5400W</b>		1140x350x160(mm) 44,90x13,78x6,30(in)	1187x410x181(mm) 46,73x16,14x7,12(in)		7,70kg 16,94lbs		Black
<b>HPRC0500</b>		closed 394x280x27,5(mm) 15,51x11,02x1,08(in)	open 464x350x27,5(mm) 18,26x13,77x1,08(in)		0,95Kg 2,09lbs		Black



Ultralight. Watertight. Smart Cases.





★ ★ ★  
PROUDLY  
**MADE IN ITALY**



**PLABER S.R.L. - HPRC CASES**

VIA DIV TRIDENTINA, 10  
I-36061 BASSANO DEL GRAPPA  
VICENZA - ITALY

TEL +39 0424 809150  
FAX +39 0424 808548

**USA OFFICE AND WAREHOUSE:**

HPRC USA  
240 ANDERSON AVENUE  
07074 MOONACHIE - NEW JERSEY

TEL +1 201 617 2000  
FAX +1 201 617 2001

**WWW.HPRC.IT**  
**E: INFO@HPRC.IT**

**HPRC® BRAND OWNED BY:**

*plaber*  
ITALIA

DISTRIBUTED BY:

