

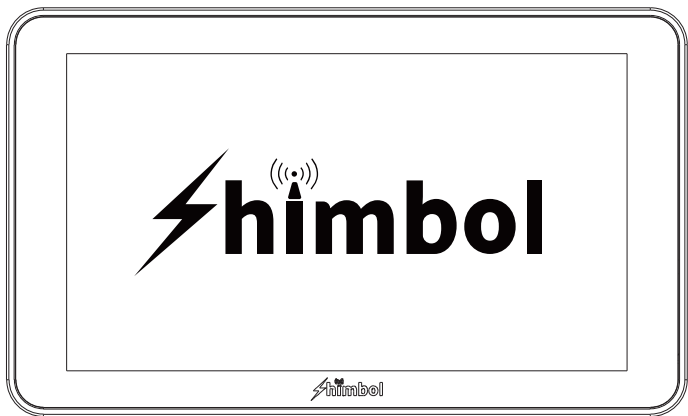

Video Recording Monitor

MEMORY I PRO



Instruction Manual

Shenzhen ZO Video Technology Co., Ltd.

Packing list

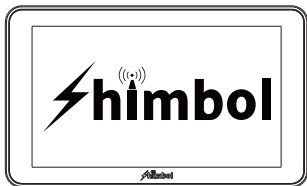

Monitor*1



SD card



Tempered Screen Protector

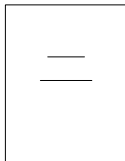

User Manual

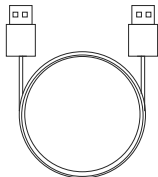

HDMI Cable*1

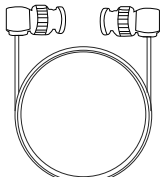

SDI Cable*1

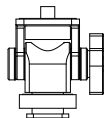

Hot Shoe Mount*1

Monitor*1

SD Card*1

Hot Shoe Mount*1

SDI Cable*1

HDMI Cable*1

Tempered Screen Protector*1

User Manual*1

Buttons and Ports

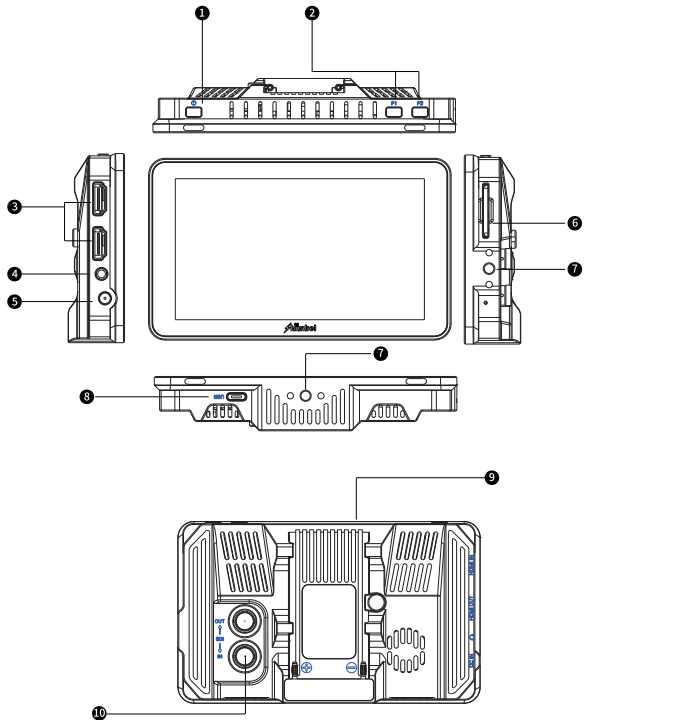

- 1 Power Button
- 2 Function Key
- 3 HDMI Interfaces
- 4 3.5mm Headphone Jack
- 5 DC IN
- 6 SD Card Slot
- 7 1/4"-20 Thread Hole
- 8 Debug Port
- 9 NP-F Battery Plate
- 10 SDI Interfaces

Catalog

1. Monitors Assist Icons	4
2. User Interface	6
3. Operation Guide	8
3.1 Boot Method	8
3.2 HDMI-SDI Interface Description	8
3.3 RGB Gain and Offset	8
3.4 Recording And Playback	9
3.5 Format SD Card	10
3.6 Shortcut Key Preset	10
3.7 High Precision Waveform	11
3.8 Matte	11
3.9 3D-LUT Input Method	12
3.10 3D-LUT Output Method	13
4. Notes	14
4.1 .Exceptions in Connection	14
4.2 .SD card Description	14
4.3 .Record and Playback	14
5. Technical Parameters	15

Monitors Assist Icons



Switching Signal



Input

HDMI-SDI



Scope Menu



Waveform

shows the levels of brightness from an input source



RGB-Paral

monitor the level of red, green and blue from an input source



Histogram

this is useful for checking if an image is under or over saturated.



Vector

visualize the dynamic range of your image



Marker Menu



Marker

mark through your chosen aspect ratio



Safe area

action area and title safe areas displayed



Anamorphic

allows you to see a correctly squeezed image when using anamorphic lenses



Center marker

mark image center



Matte

Multiple modes are available



Grip

Multiple lines are selected

Monitors Assist Icons



Focus Menu



Peaking

ensure your recordings are always in focus



Zoom

zoom in image



Exposure Menu



Zebra

use zebra to check exposure and set exposure levels



False color

a visualization of exposure across the image



Monochrome

monochrome display mode



Color Menu



3D-LUT

3D-LUT loading & updating



Gamma

gamma setting



HDR

HDR monitoring



Color temperature

color temperature setting



Lock Screen



Main Menu

User Interface

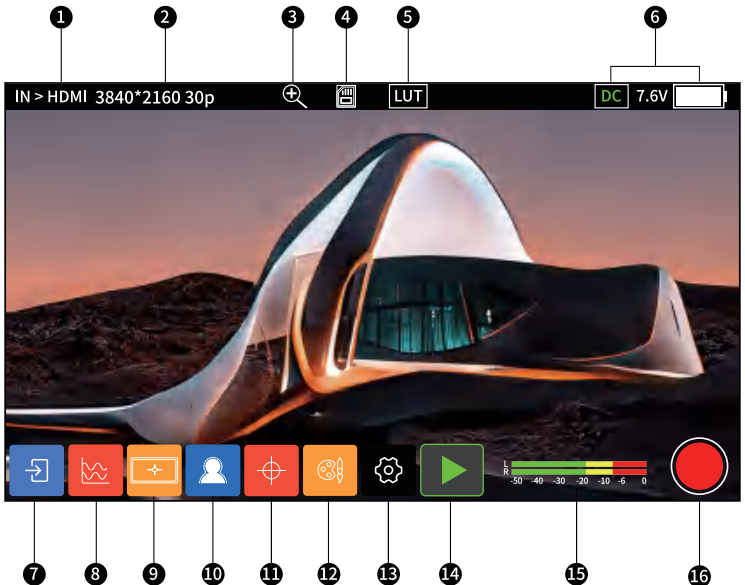

1 Video Input

2 Resolution

3 Zoom

4 SD Card

5 3D-LUT

6 Power Indication

7 Switching Signal

8 Waveform Menu

9 Marker Menu

10 Focus Menu

11 Exposure Menu

12 Color Menu

13 System Settings

14 Playback Button

15 Audio Meter

16 REC Button

User Interface

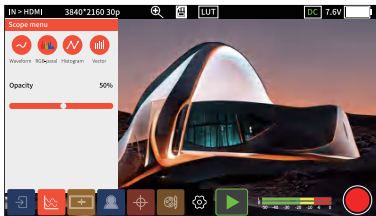

Scope Menu

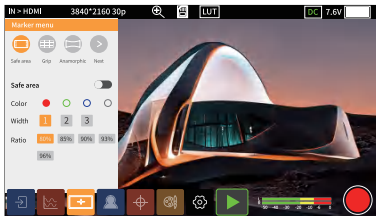

Marker Menu

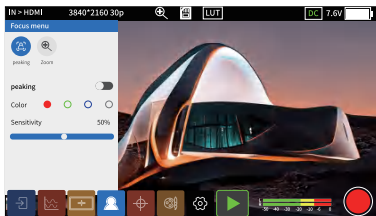

Focus Menu

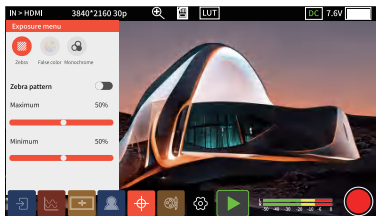

Exposure Menu



Color Menu

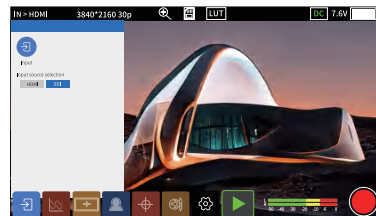

Switching Signal Menu

Operation Guide

3.1.Boot Method

Short press the power on/off button to turn on the monitor, long press 3 seconds to turn it off.

3.2.HDMI-SDI Interface Description

SDI interface is located on the back of the host, HDMI interface is located on the side of the host, with a dedicated HDMI/SDI cable for close-up real-time monitoring.

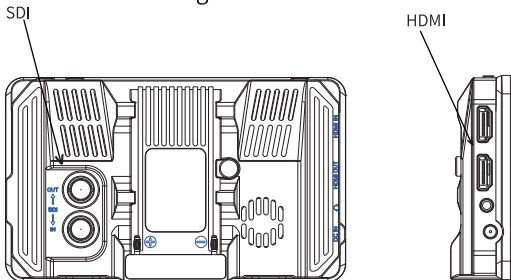

3.3.RGB Gain and Offset Control Functions

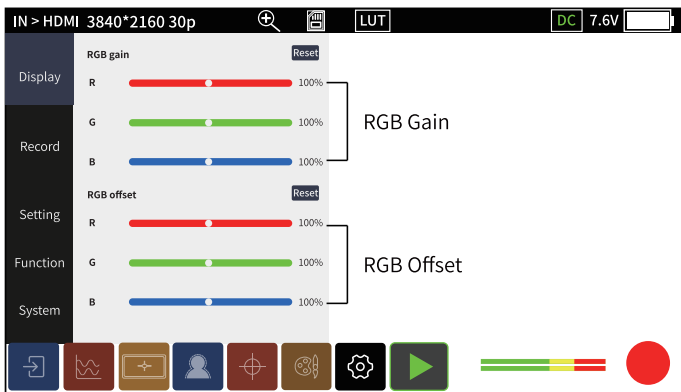

Operation Guide

3.4. Recording Playback

a. Custom File Name

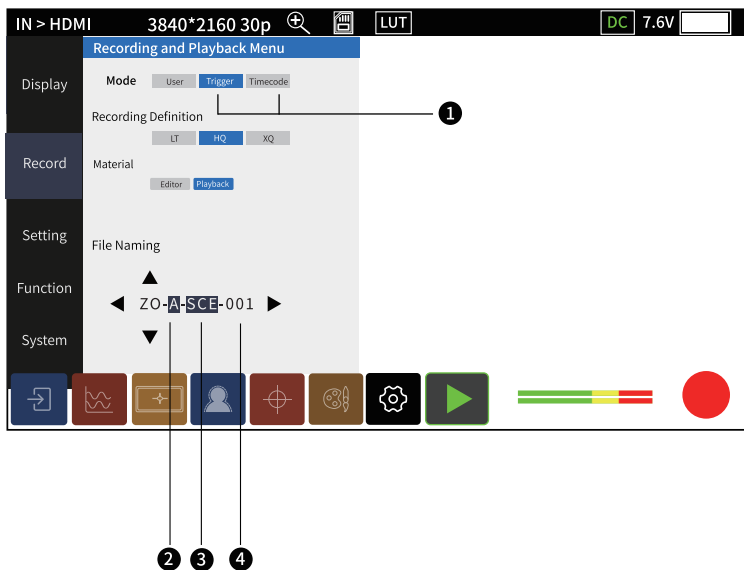

- 1 Trigger/TimeCode camera synchronization recording function
- 2 This position represents the camera position, click up and down to adjust
- 3 This position represents the shooting site, click up and down to adjust
- 4 This position represents the number of cameras, it is not adjustable and the digital number increases with the number of shootings

Operation Guide

3.5.Format SD Card



3.6.Shortcut Key Preset

There are two shortcut keys, F1 and F2, on the top of the host, and you can choose function presets.

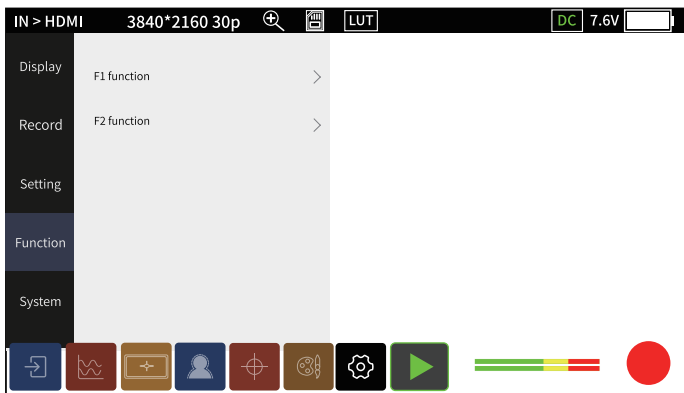

Operation Guide

3.7.High Precision Waveform

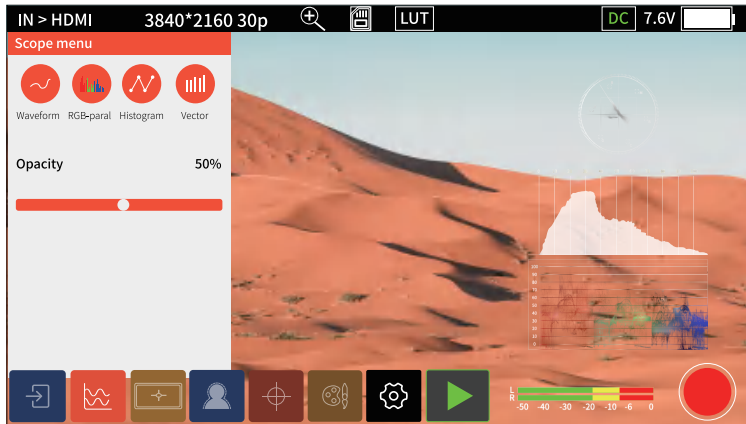

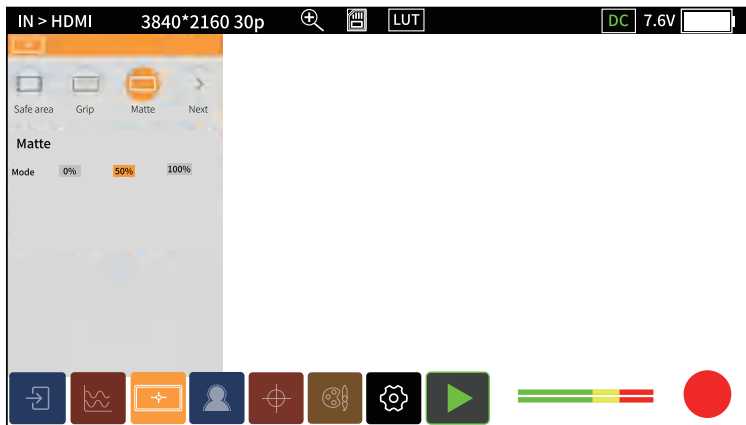

3.8.Matte

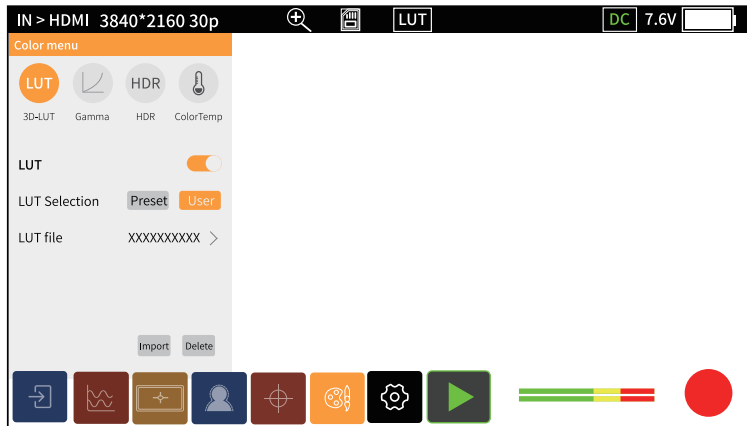

Operation Guide

3.9 3D-LUT Input Method



- 1 Place the LUT file in the LUT folder on the SD card and insert the SD card into the monitor
- 2 Click the Color Menu-3D-LUT, turn on , and then selecting Custom, click the Import button and wait for the system to retrieve the LUT file in the SD card that needs to be loaded
- 3 Click on the LUT file that needs to be loaded, then click Import and wait for the file to be imported into the system
- 4 Click the LUT file, enter the file selection, select the desired LUT, and click to confirm that the LUT is loaded successfully

Note: LUT file name only support English, do not allow any other languages , special characters, spaces, otherwise it will fail to be imported !

Operation Guide

3.10 3D-LUT Output Method

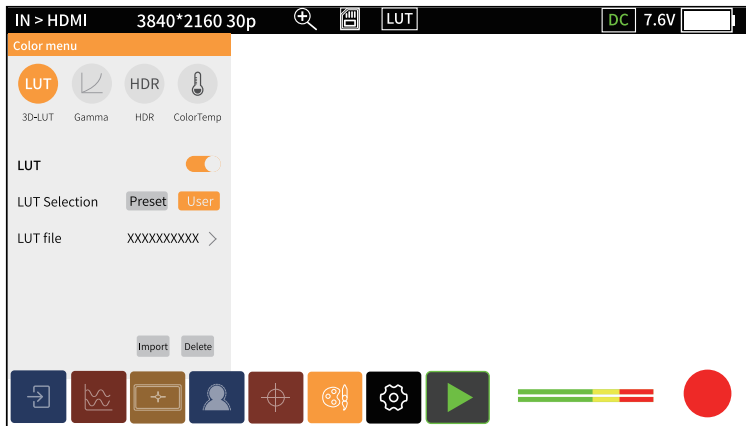

- 1 Click the color management-3D-LUT icon, open X select the corresponding LUT file, and the preset LUT color adjustment effect can be recorded into the file synchronously during recording.
- 2 The LUT for HDMI/SDI output is the same as the LUT that is turned on.

Notes

1.Exceptions in Connection

a.Zoom, Anamorphic, Waveform, these three functions can only be opened one at a time. Such as when the Anamorphic function is open, has opened the Zoom or Waveform will be forced to close.

b.When HDMI IN, there is no SDI output. When SDI IN, both HDMI and SDI can be output.

2.SD Card Description:SD Card Identification and Use Problems

2.1 The SD card of this product does not support hot-swapping, if the SD card is inserted and removed during use, causing abnormalities such as the card cannot be recognized and the screen interface cannot be operated, please restart the device.

2.2 The SD card format used in this monitor is FAT32 and it is different from the card format used in the camera,so can not be mixed.

2.3 The newly purchased SD card has to formatting by monitor's "SD Card Format" function before normal use.

2.4 Recommended card capacity is 32G-128G, MAC computers do not recognise SD cards over 32G in FAT32 format.

3. Record and Playback:

The Abnormal Phenomenon of Using Recording and Playback

Synchronous recording (Trigger/TimeCode)

3.1 The camera needs to support HDMI Trigger/TimeCode

3.2 Trigger/TimeCode function is turned on

3.3 Some of the cameras have been having TimeCode output, when TimeCode mode ON, will trigger automatic recording

Technical Parameters

Model No.:	MEMORY I PRO		
Screen Size	5.5"TP		
Screen Resolution	1920*1080		
Brightness	2000cd/m ²		
Power Consumption:	< 12W	Viewing Angle:	178° (H/V)
Interface:	DC In , HDMI input, SDI input, HDMI output, SDI output, 3.5mm Headphone out, SD card		
Unit Size	147.8*88.8*26.5mm		
Contrast Ratio	1200:1		
Power Supply Method	NP-F / DC IN		
Input Voltage	DC7-16V		
Weight	305g		
Video Recording Format	MP4(SD card format FAT32) ①		
LUT Format	cube file (17*17*17 and 33*33*33) ②		
Firmware Updates	SD card updates		
Audio Frequency	48kHz		
HDMI Input Signal Formats	4096*2160p25/24/23.98 3840*2160p30/23.98/25/24/23.98 1920*1080p60/59.94/50/30/29.97/25/24/23.98 1920*1080i60/59.94/50 1280*720p60/59.94/50		
SDI Input Signal Formats	1920*1080p60/59.94/50/30/29.97/25/24/23.98 1920*1080PSF30/29.97/25/24/23.98 1920*1080i60/59.94/50 1280*720p60/59.94/50		
HDMI Output Signal Formats	1920*1080p60/50/30/25/24 1920*1080i60/50 1920*p60/50		
SDI Output Signal Formats	1080p60/50/30/25/24/ 1080i60/50 720p60/50		
HDMI&SDI-Lut Output	support		

Please note: ① Recording file

It is under "Video" folder of root directory in SD card.

② The LUT file to be imported

It is under "Lut" folder of root directory in SD card, and the LUT files should not exceed 50.

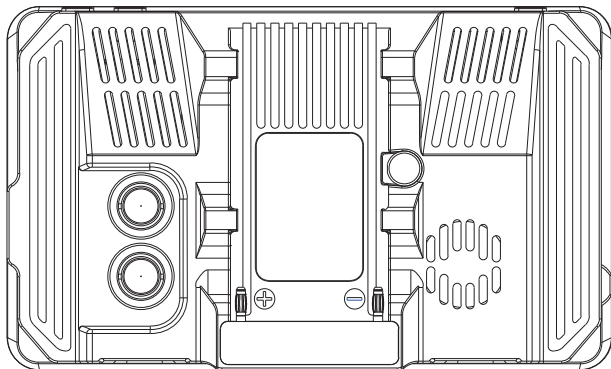

Tel+86 0755-21004986

URL:www.zeroone-video.com

Address:2C, 2nd Floor, Building 6, Longbi Industrial Park
No.27 Dafa Road, Bantian Street, Longgang District, Shenzhen

Shenzhen ZO Video Technology Co., Ltd.